



# M1F THRU M7F

Reverse Voltage - 50 to 1000 Volts Forward Current - 1.0 Ampere

## SURFACE MOUNT GENERAL RECTIFIER

### Features

- ◆ The plastic package carries Underwriters Laboratory Flammability Classification 94V-0
- ◆ Idea for printed circuit board
- ◆ Glass passivated junction
- ◆ Low reverse leakage
- ◆ High forward surge current capability
- ◆ High temperature soldering guaranteed  
250 °C/10 seconds at terminals

### Mechanical Data

Case: SMAF molded plastic body  
 Terminals: Solderable per MIL-STD-750, Method 2026  
 Polarity: Polarity symbol marking on body  
 Mounting Position: Any  
 Weight: 0.0018 ounce, 0.064 grams

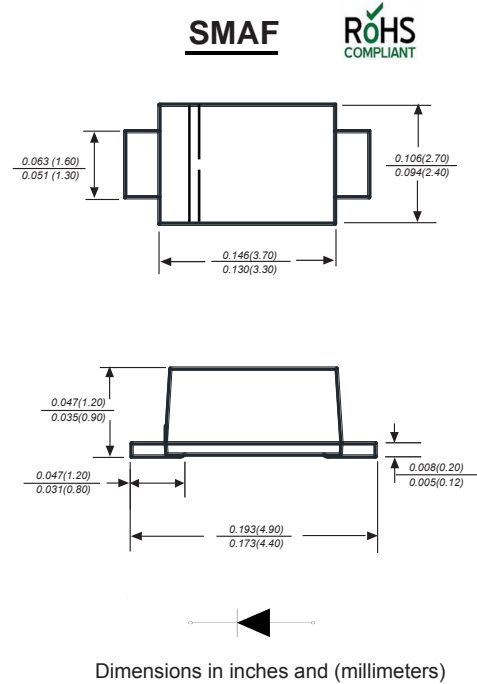

### Maximum Ratings And Electrical Characteristics

Ratings at 25°C ambient temperature unless otherwise specified.

Single phase half-wave 60Hz, resistive or inductive load, for capacitive load current derate by 20%.

Parameter	SYMBOLS	M1F	M2F	M3F	M4F	M5F	M6F	M7F	UNITS
Marking Code		MDD M1F	MDD M2F	MDD M3F	MDD M4F	MDD M5F	MDD M6F	MDD M7F	
Maximum repetitive peak reverse voltage	$V_{RRM}$	50	100	200	400	600	800	1000	V
Maximum RMS voltage	$V_{RMS}$	35	70	140	280	420	560	700	V
Maximum DC blocking voltage	$V_{DC}$	50	100	200	400	600	800	1000	V
Maximum average forward rectified current at $T_L=75^\circ\text{C}$	$I_{(AV)}$	1.0							A
Peak forward surge current 8.3ms single half sine-wave superimposed on rated load (JEDEC Method)	$I_{FSM}$	30							A
Maximum instantaneous forward voltage at 1.0A	$V_F$	1.10							V
Maximum DC reverse current at rated DC blocking voltage $T_A=25^\circ\text{C}$ $T_A=125^\circ\text{C}$	$I_R$	5.0 50.0							$\mu\text{A}$
Typical junction capacitance (NOTE 1)	$C_J$	15.0							pF
Typical thermal resistance (NOTE 2)	$R_{\theta JA}$	75.0							$^\circ\text{C}/\text{W}$
Operating junction and storage temperature range	$T_J, T_{STG}$	-55 to +150							$^\circ\text{C}$

Note: 1. Measured at 1MHz and applied reverse voltage of 4.0V D.C.  
 2. P.C.B. mounted with 0.2x0.2" (5.0x5.0mm) copper pad areas



# M1F THRU M7F

Reverse Voltage - 50 to 1000 Volts Forward Current - 1.0 Ampere

## Typical Characteristics

AVERAGE FORWARD RECTIFIED CURRENT,  
AMPERES

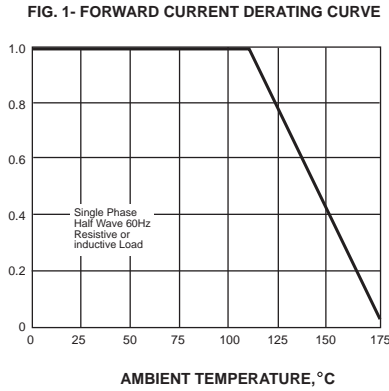

PEAK FORWARD SURGE CURRENT,  
AMPERES

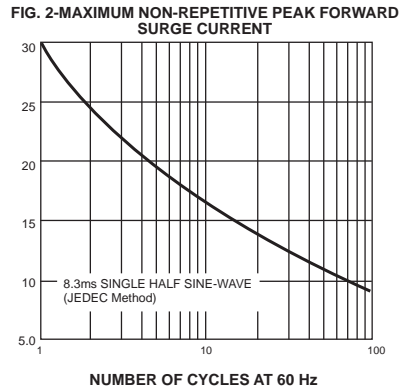

INSTANTANEOUS FORWARD CURRENT,AMPERES

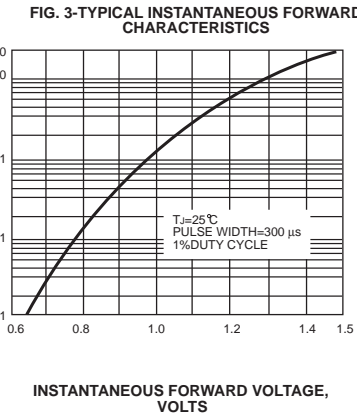

INSTANTANEOUS REVERSE CURRENT,  
MICROAMPERES

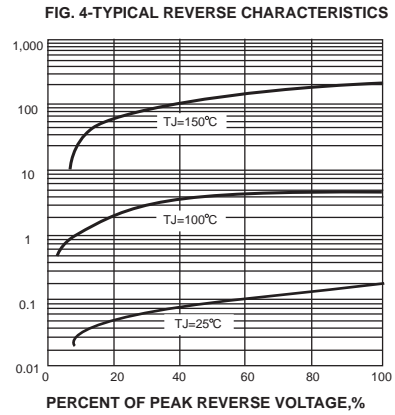

JUNCTION CAPACITANCE, pF

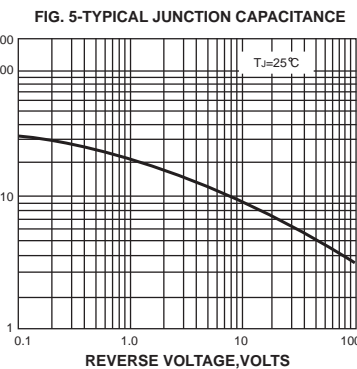

TRANSIENT THERMAL IMPEDANCE,  
°C/W

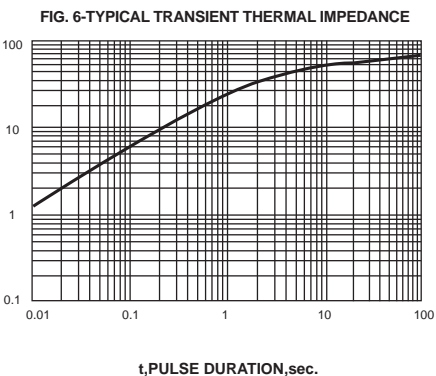

The curve above is for reference only.



# M1F THRU M7F

Reverse Voltage - 50 to 1000 Volts Forward Current - 1.0 Ampere

## Packing information

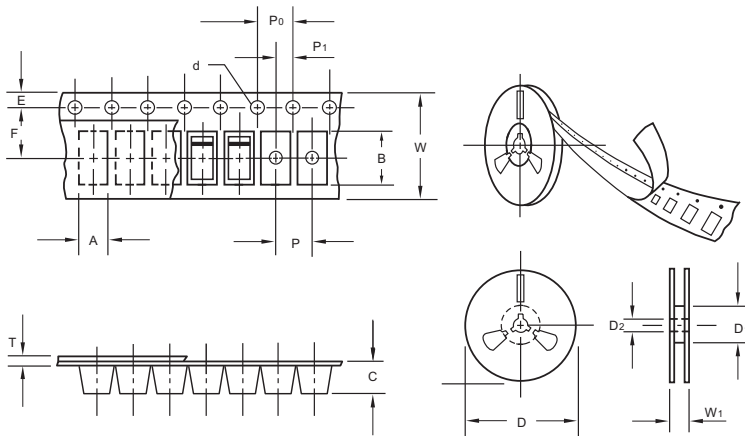

unit:mm

Item	Symbol	Tolerance	SMAF
Carrier width	A	0.1	2.80
Carrier length	B	0.1	4.75
Carrier depth	C	0.1	1.42
Sprocket hole	d	0.05	1.50
7" Reel outside diameter	D	2.0	178.00
7" Reel inner diameter	D1	min	54.40
Feed hole diameter	D2	0.5	13.00
Sprocket hole position	E	0.1	1.75
Punch hole position	F	0.1	5.05
Punch hole pitch	P	0.1	4.00
Sprocket hole pitch	P0	0.1	4.00
Embossment center	P1	0.1	2.00
Overall tape thickness	T	0.1	0.30
Tape width	W	0.3	8.00
Reel width	W1	1.0	12.30

Note: Devices are packed in accordance with EIA standard RS-481-A and specifications listed above.

## Reel packing

PACKAGE	REEL SIZE	REEL (pcs)	COMPONENT SPACING (m/m)	BOX (pcs)	INNER BOX (m/m)	REEL DIA, (m/m)	CARTON SIZE (m/m)	CARTON (pcs)	APPROX. GROSS WEIGHT (kg)
SMAF	7"	3,000	4.0	6,000	210*208*203	178	400*265*400	120,000	10.0

## Suggested Pad Layout



Symbol	Unit (mm)	Unit (inch)
A	1.8	0.071
B	1.6	0.063
C	3.8	0.150
D	2.2	0.087
E	5.4	0.213

## Important Notice and Disclaimer

Microdiode Electronics (Jiangsu) reserves the right to make changes to this document and its products and specifications at any time without notice. Customers should obtain and confirm the latest product information and specifications before final design, purchase or use.

Microdiode Electronics (Jiangsu) makes no warranty, representation or guarantee regarding the suitability of its products for any particular purpose, nor does Microdiode Electronics (Jiangsu) assume any liability for application assistance or customer product design. Microdiode Electronics (Jiangsu) does not warrant or accept any liability with products which are purchased or used for any unintended or unauthorized application.

No license is granted by implication or otherwise under any intellectual property rights of Microdiode Electronics (Jiangsu).

Microdiode Electronics (Jiangsu) products are not authorized for use as critical components in life support devices or systems without express written approval of Microdiode Electronics (Jiangsu).